

Primoll

DIRECT VENT GAS FIREPLACES

HEAT & GLO



Primo II

Create a place you look forward to each day—and can enjoy in any season or climate. At its heart is the Primo II luxury linear gas fireplace. Tailor the look to fit your decor. Choose low or no heat. Kick back with family or friends at a time when rest and rejuvenation have never been more important.



Primo II 72, shown with fluted black glass interior panels and Birch logs

The clean face design of Primo II brings out big flames in an opening that's a full 18" tall, with 48", 60" or 72" single or double-sided designs. View the same beautiful fire from your living room and patio with our indoor/outdoor kit. And craft your look with a choice of crushed glass, logs and interior panels that blend beautifully whether your home is modern or transitional.

With heat control, you can bring combustibile materials up to the fireplace opening and place your TV or artwork just inches above it, while SafeSurface™ glass protects little hands with no need for a screen.



See it burn!



PRIMO II 72 double-sided with indoor/outdoor kit, shown with Stone Column interior panels and Birch logs

PRODUCT DETAILS

- Tall 18" viewing height for generous view of flickering flames
- 48", 60" and 72" wide in one-sided or double-sided models
- Safely install combustible materials up to the fireplace opening
- Multi-colored LED ember lighting highlights crushed glass
- Five interior panel styles and three log designs for a custom look
- SafeSurface glass keeps hands safe without a safety screen
- Easy control with touchscreen remote, wireless wall switch, app or voice control
- Cool-wall technology enables installation of TV or artwork overhead
- Optional automatic heat distribution in your space for warmth when it's wanted
- Optional indoor/outdoor kit for double-sided application

SINGLE-SIDED



DOUBLE-SIDED





Primo II 48 shown with Stone Column interior panels and crystal glass media

INTERIOR OPTIONS



Optional decorative logs customize each fireplace for a unique design. Each set elevates the realism by arching over the flames for a true interaction with the fire.

FIVE INTERIOR PANEL OPTIONS



STONE COLUMN



ARCHITECTURAL



FLUTED BLACK GLASS



MARBLE BLACK GLASS < two-sided panel >



REFLECTIVE BLACK GLASS

THREE LOG SETS



BIRCH



DRIFTWOOD



OAK

FOUR CRUSHED GLASS COLORS + RIVER ROCK STONES



CRYSTAL GLASS



COPPER GLASS

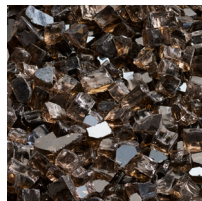

SMOKED GLASS



GRAPHITE GLASS

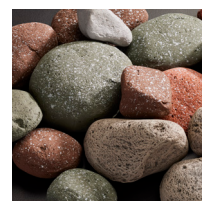

RIVER ROCK STONES

SEVEN LED EMBER BED LIGHTING COLORS



WHITE LIGHT



AQUA LIGHT



BLUE LIGHT

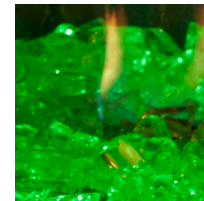

GREEN LIGHT



ORANGE LIGHT



RED LIGHT



MAGENTA LIGHT

POWERFLOW™ II TECHNOLOGY



Our exclusive PowerFlow II technology redirects the flow of heat to the outside of the home to keep outer glass temperatures safe and maintain a cool wall, enabling you to add a TV or heat-sensitive materials just inches above your fireplace.



Although the Primo II is specifically designed for no heat, an optional heat management system (PRIMO-HEAT-DUCT) may be utilized to capture a low amount of heat. This heat can be transferred into the same room or directed to another area of the home up to 25 feet away.

A STANDARD POWERFLOW II

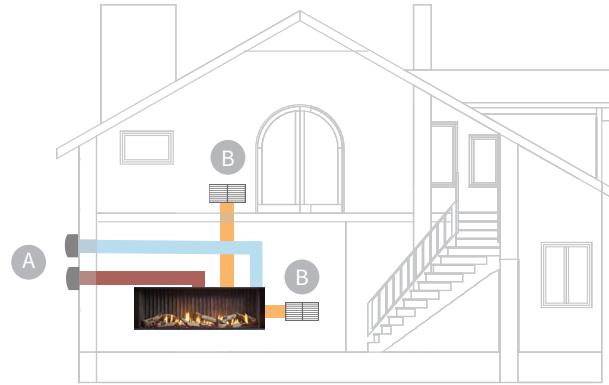

B OPTIONAL PRIMO-HEAT-DUCT



-  AIR INTAKE
-  EXHAUST
-  OPTIONAL PRIMO-HEAT-DUCT

PRIMO II TECHNOLOGIES



INTELLIFIRE TOUCH® TECHNOLOGY

IntelliFire Touch is our most advanced intermittent-pilot ignition (IPI) system, making running your appliance simple, smart and safe. Utilize the included touchscreen remote control or add a wireless wall switch or IntelliFire® app for the solution that fits your lifestyle.



MULTI-COLORED LED LIGHTING TECHNOLOGY

Superior performance and extended efficiency. This technology supplies high-contrast, brilliant lighting to accentuate the flames. Can be used as mood lighting with or without the flames. Able to control the lighting with the included touchscreen remote (RC450).



DIRECT VENT TECHNOLOGY

Direct Vent fireplaces remove 100% of combustion exhaust and odors outside of the home. These sealed fireplaces provide optimal heat, conserve energy and ensure clean, safe indoor air quality.



SAFESURFACE GLASS

SafeSurface glass keeps hands safe without the need for a safety screen thanks to double-pane glass and internal cooling technology.

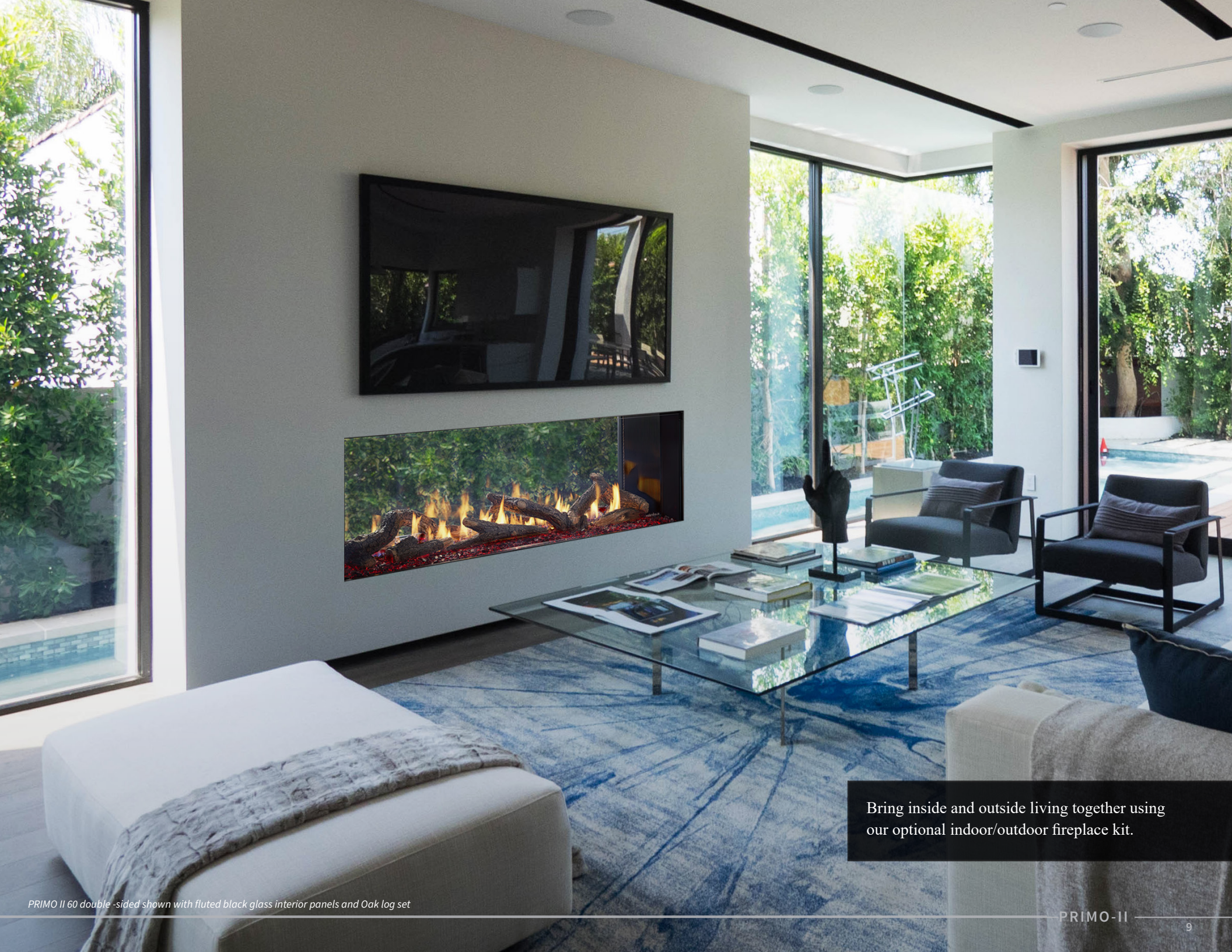

Bring inside and outside living together using our optional indoor/outdoor fireplace kit.

PRIMO II 60 double-sided shown with fluted black glass interior panels and Oak log set

CONTROLS

INTELLIFIRE APP

All the features of a remote control with an app installed on your smart device. Monitor your fire from anywhere or even control it with the sound of your voice.



IntelliFire is compatible with voice assistants Amazon Alexa and Google Assistant. Only select features are available on the app.

TOUCHSCREEN REMOTE

Features: on/off, flame height adjustment, lights adjustment, child lock, timer mode, wall docking station.



WIRELESS WALL SWITCH

Features: on/off, battery strength indicator.



PRIMO II SPECIFICATIONS

MODEL	WIDTH		HEIGHT		DEPTH		GLASS SIZE	BTU/HOUR INPUT
	UNIT	FRAMING	UNIT	FRAMING	UNIT	FRAMING		
PRIMO-II-48, PRIMO-II-48ST	64-3/8" [1635]	66-3/4" [1695]	40-13/16" [1037]	45" [1143]	18-1/4" [464]	18" [457] ST: 17" [432]	48" x 18" [1219 X 457]	31,500 - 45,000 BTUs (NG) 31,000 - 42,000 BTUs (LP)
PRIMO-II-60, PRIMO-II-60ST	76-3/8" [1940]	78-3/4" [2000]	40-13/16" [1037]	45" [1143]	18-1/4" [464]	18" [457] ST: 17" [432]	60" x 18" [1524 X 457]	39,500 - 57,000 BTUs (NG) 36,500 - 50,000 BTUs (LP)
PRIMO-II-72, PRIMO-II-72ST	88-3/8" [2245]	90-3/4" [2305]	40-13/16" [1037]	45" [1143]	18-1/4" [464]	18" [457] ST: 17" [432]	72" x 18" [1829 x 457]	42,000 - 58,500 BTUs (NG) 40,500 - 55,000 BTUs (LP)

MODEL	A	B	C	D	E
PRIMO48, PRIMO48ST	64-3/8" [1635]	54-3/16" [1375]	44-5/8" [1134]	48" [1219]	67-3/16" [1707]
PRIMO60, PRIMO60ST	76-3/8" [1940]	60-3/16" [1529]	56-5/8" [1438]	60" [1524]	79-3/16" [2011]
PRIMO72, PRIMO72ST	88-3/8" [2245]	66-3/16" [1681]	68-5/8" [1743]	72" [1829]	91-3/16" [2316]

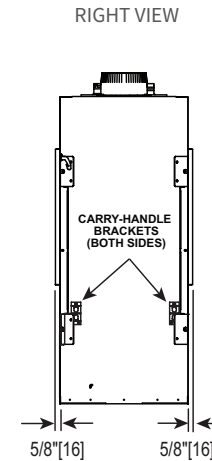
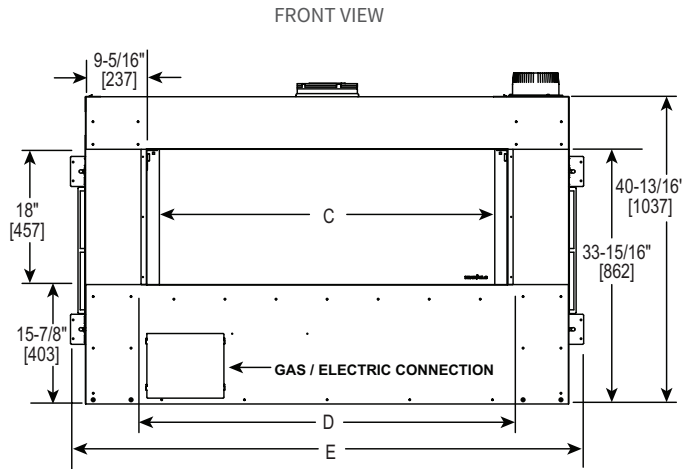
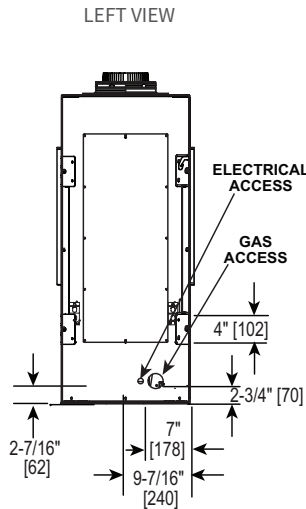
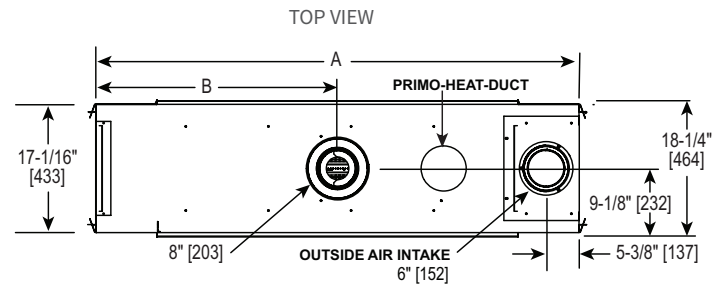

Dimensions are in inches and millimeters. Product information is not complete and is subject to change without notice. Product installation must adhere strictly to instructions shipped with product. We recommend measuring individual units at installation. Assumes the use of 1/2" sheetrock. NOTE: Combustible material should not cover the face.



Refer to installation manual for detailed specifications on installing this product. Heat & Glo® reserves the right to update units periodically. The flame and ember appearance may vary based on the type of fuel burned and the venting configuration used. Actual product appearance, including flame, may differ from product images.



PRIMO II 72 double-sided, shown with Architectural interior panels and Driftwood logs

For complete information on this model, please contact us at:

heatglo.com | (888) 427-3973

 facebook.com/HeatandGlo
 twitter.com/HeatandGlo
 youtube.com/HeatandGlo

HEAT & GLO

No one builds a better fire

LIMITED LIFETIME WARRANTY

The strongest in the industry, Heat & Glo® provides a limited lifetime warranty on the most important aspects: firebox and heat exchanger.

For full warranty details, visit heatglo.com



HNG-1144U-0623

